

The Design and Development of TWISTER II: Immersive Full-color Autostereoscopic Display

Kenji Tanaka¹, Junya Hayashi, Yutaka Kunita², Masahiko Inami, Taro Maeda,
Susumu Tachi

Graduate School of Information Science and Technology, The University of Tokyo
7-3-1 Hongo, Bunkyo-ku, Tokyo 113-8656, Japan
{tanaken, junya, kuni, minami, maeda, tachi}@star.t.u-tokyo.ac.jp

Abstract

This paper reports the design, development, and preliminary performance evaluation of TWISTER II (Telexistence Wide-angle Immersive STEReoscope model II), an immersive full-color autostereoscopic display. The project is designed for the purpose of a face-to-face telecommunication system called "mutual telexistence."

The basic idea of mutual telexistence is the projection of human beings into a mutual virtual environment in real time. Each human user resides inside a booth with a spinning circular mechanism, which plays the role of both the display and the input device. With plural booths, each user can see the three dimensional figures of other users working in real time in the mutual virtual environment. We implemented the display partially, and confirmed its performance as a stereoscopic display of full-color still images. It has been found experimentally to have enough tonal resolution and brightness. We studied the display gamma characteristics, as well as the display stability: to what extent a human observer can fuse an image with rotating LED arrays. We also focused on the performance of the "moving parallax barrier," which basically proved to contribute to stereopsis.

Key words: mutual telexistence, immersive display, LED display, rotating parallax barrier, three dimensional autostereoscopic display

1. Introduction

Our goal is face-to-face tele-communication, where people in distant locations can communicate as if they were in the same virtual three dimensional space[1][2]. One of the most essential elements for such a system is the sense of presence. However, in conventional systems, including IPT (immersive projection technology) based[3][4] and HMD (head mounted display) based systems, the mechanism itself for stereopsis, such as stereo glasses, damages the sense of presence because it hides the observer's face. Moreover, those devices makes a sense of discomfort for the observer. On the other hand, several kinds of autostereoscopic displays have been proposed[5][6][7]. But

even with these systems, it was difficult in principle to achieve a well-balanced performance: a wide angle of field, a sufficient spatial resolution, a wide observation angle for stereopsis, and zero crosstalk.

To solve these problems, we initially proposed TWISTER (Telexistence Wide-angle Immersive STEReoscope) as a booth for face-to-face tele-communication, by adopting a "rotating parallax barrier" method[8]. By developing TWISTER I[9][10], the first prototype, we have so far confirmed the validity of this method for a wide-angle autostereoscopic display. We have also studied on the capture system such as real-time rendering system of moving objects[11][12][13]. We are currently developing TWISTER II[14], which features full-color high resolution, and high frame rate motion picture presentation. To date, we have implemented it partially, and have confirmed its performance as a stereoscopic display of full-color still images. The photograph of TWISTER II is shown in Figure1.



Fig. 1: The photograph of TWISTER II

2. The Design

2.1 The Concept

As shown in Figure 2, TWISTER has rotating display-and-camera units surrounding the observer. One unit consists of two LED arrays, a parallax barrier, and a camera (Figure 3). Each LED array consists of pairs of red, green, and blue LED's, and displays time-varying patterns so that the observer can perceive an image. Due to the

¹ Kenji Tanaka is with Sony Corporation.

² Yutaka Kunita is currently with Nippon Telegraph and Telephone Corporation.

use of LED, TWISTER can be used as a display of high intensity full-color images for use in a bright room.

The rotation of the display unit makes it a wide angle display. In fact, the angle of view as a normal display is 360 degrees.

In addition, since the horizontal and the temporal resolutions of this display are determined by the period of the LED emission, the spatio-temporal resolution can be adaptive and optimized to the subject.

The key device for autostereopsis is the parallax barriers. One of the LED arrays is for the left eye, and the other is for the right eye. Because the parallax barrier obscures the opposite side LED emission, different images are shown to the left and right eyes (Figure4). The angle of view as a stereoscopic display depends on the direction and the position of the observer. If the head of the observer is fixed, it exceeds 120 degrees in an ideal condition. On the other hand, if the observer always faces the center of the image region of interest, it can be 360 degrees.

With the moving parallax barriers, the crosstalk between the left eye image and the right eye image can be almost zero. It is a powerful advantage in comparison with other stereoscopic vision systems.

Since the rotating unit has cameras on it, you can capture the image of the observer simultaneously. With this system the face of the observer is clearly captured, and a natural non-verbal communication between plural booths is achieved when the image data is transferred in real-time.

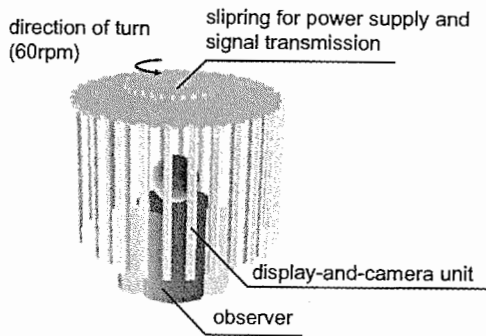

Fig. 2: The overview of TWISTER II

With TWISTER II, we are basically trying to improve the display performance. On its designing, we focused particularly on the following effects:

- spatio-temporal characteristics of the display
- tonal characteristics of the LED array display
- depth resolution for three dimensional expression
- area of image projection region
- observation area for stereopsis
- temporal stability of the fused image

Table1 at the end of this report is the goal and actual specifications of TWISTER II.

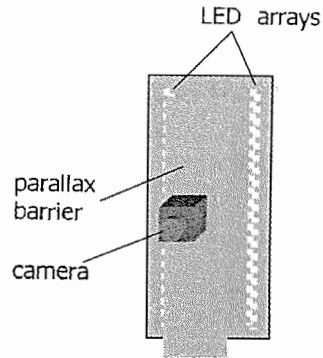

Fig. 3: The display-and-camera unit – two LED arrays, a parallax barrier, and a camera

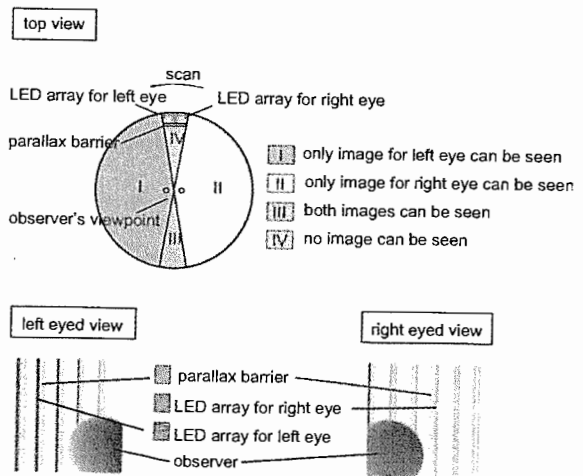

Fig. 4: The principle of the rotating parallax barrier

2.2 Design of Capture

Parallax capture

In general, in order to display three dimensional objects for an arbitrary viewpoint outside a closed surface, ray information is required from a sufficient variation of directions inward, and at points of sufficient density over a closed surface that separates the observer and the object (Fig.5 a, b).

However, it is difficult to capture images from continuous viewpoints simultaneously because each camera occupies physical space. To increase the number of viewpoints, two solutions are available: reduce the size of the sensors (c), or use the camera motion (d).

TWISTER II employs both means. We are planning to equip TWISTER II with 30 cameras all around. At the same time we are going to rotate the booth at a sufficient speed so that the time for each camera to pass through the shooting points becomes negligible compared with the video rate.

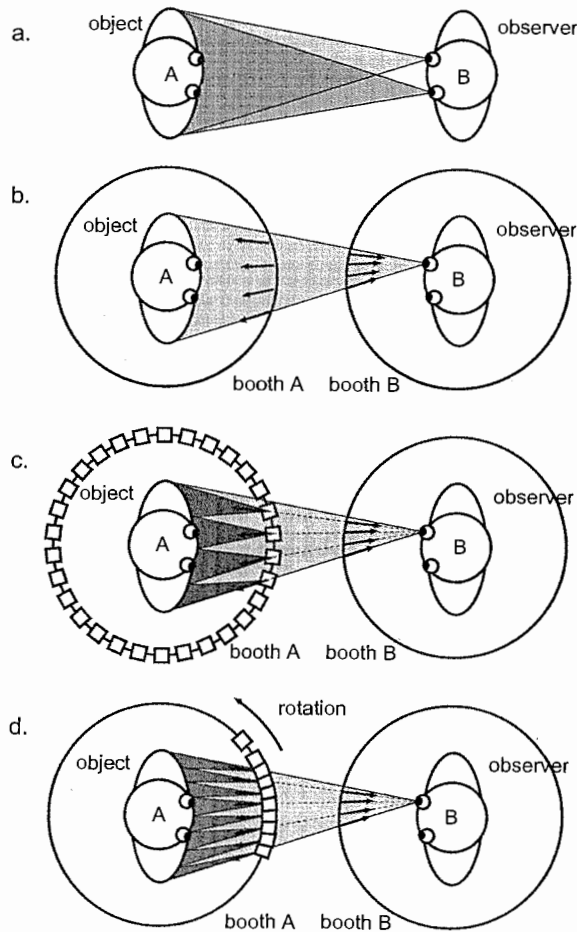

Fig. 5: Capture and display of ray information with ideal booths

2.3 Design of Display

Horizontal Resolution

The horizontal resolution of TWISTER II display is determined by the period of LED emission. For example, in order to display an image at a resolution of 6/20 visual acuity, 20 lines should be displayed in one degree assuming that the booth is rotating at a speed of 60 rpm. This corresponds to a horizontal resolution of 7200 lines over 360 degrees, and an LED scan rate of 7.2kHz.

Vertical Resolution

The vertical pitch of LED's determines the vertical resolution. It's designed to be 3.5 mm, which corresponds to 1/20 of visual acuity when observed from the distance of 0.6 meters.

One possibility to improve the vertical resolution is mechanical interlacing: the layout of LED element is dephased alternately with respect to each unit.

Figure 6 shows the layout of LED unit with two phases. In (a), the total vertical resolution of the units equals that of one unit. On the other hand, with mechanical interlacing (b), the total resolution is effectively twice that of one unit. With three phases, one can achieve the resolution of three times, which corresponds to 3/20 of visual acuity.

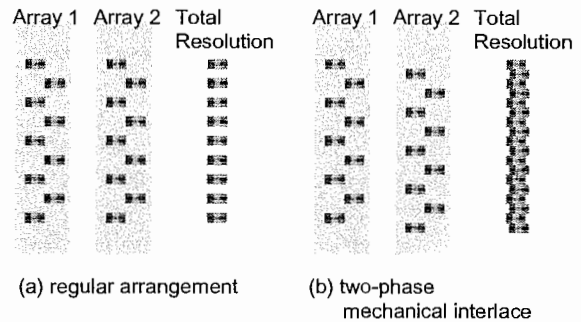

Fig. 6: The principle of mechanical interlacing

Temporal resolution

As the number of phases of mechanical interlacing increases and the horizontal resolution increases, the temporal resolution for a still image decreases. The reduction of temporal resolution can be ignored for the still objects, but not for moving objects. The TWISTER II display is capable of varying and making the optimal balance for the spatial and temporal resolutions, according to the characteristics of the object.

Moving Parallax Barriers

The parallax barrier obscures the crosstalk between the two LED arrays (one for each eye), in order to show different images to the left and right eyes. Shown in Figure 4 is the principle of this method. The left and right eyes are required to be located inside the area I and II respectively. In area III, both images can be seen, and in area IV, no image can be seen.

The observation area for stereopsis can be estimated using the parameters detailed below. Figure 7 shows the detail of Figure 4 top view. W_{LED} in (a) stands for the actual size of LED element³, which was ignored in Figure 4. The lines (a, b, c, d) stand for the half lines which connect the edge of LED elements and the edge of the barrier. The center gap ($W_{centergap}$) is defined as follows:

$$W_{centergap} = \max(\overline{S_b S_c}, \overline{S_d S_a}) \quad (1)$$

where $\max(a, b)$ indicates the maximum of a or b , and S_l stands for the x -intercept of l . The center gap limits the observation area for stereopsis, because the left eye can't exceed the left limit for instance. If the center gap equals to zero, the observation area for stereopsis on x -axis will equal the gap of the eyes (D_{eyes}).

To minimize the center gap, two points P_{bd} and P_{ac} are to be located on the x -axis, where P_{lm} stands for the intersection of l and m . Under this condition, the center gap equals $\overline{P_{bd} P_{ac}}$, and is evaluated as follows:

$$W_{centergap} = W_{LED} \cdot \frac{L_{base} - D_{barrier}}{D_{barrier}} \quad (2)$$

This means the larger $D_{barrier}$ decreases the center gap. Practically, as large $D_{barrier}$ limits the movement of the observer, we designed it to be about one fourth of the radius of the booth (L_{base}). As a result the center gap ($W_{centergap}$) becomes 21 mm, and the size of the observation area for stereopsis becomes 54 mm on x -axis.

Size of the booth

The distance between the observer's viewpoint and the LED array is designed to be approximately 0.6 meters. Under this condition, according to the relation of accommodation and convergence, the observer is able with convergence to fuse an image of an object at a distance from 0.17 to 3 meters (Figure 8). This distance complies with the assumed inter-booth communication.

Safety shield

We are going to put an transparent acrylic cylinder between the observer and the rotating units for safety. The noise of the rotating body is so subtle even without the safety shield that it doesn't annoy the observer.

Data Transmission

We anticipate transmitting the motion picture in NTSC format. It has been proven possible to transmit NTSC signal via slip-ring without degradation. To date, we have implemented the programmed pseudo-motion picture display as described later.

3. The Implementation

In order to confirm these characteristics, we have implemented and evaluated the display part of the system.

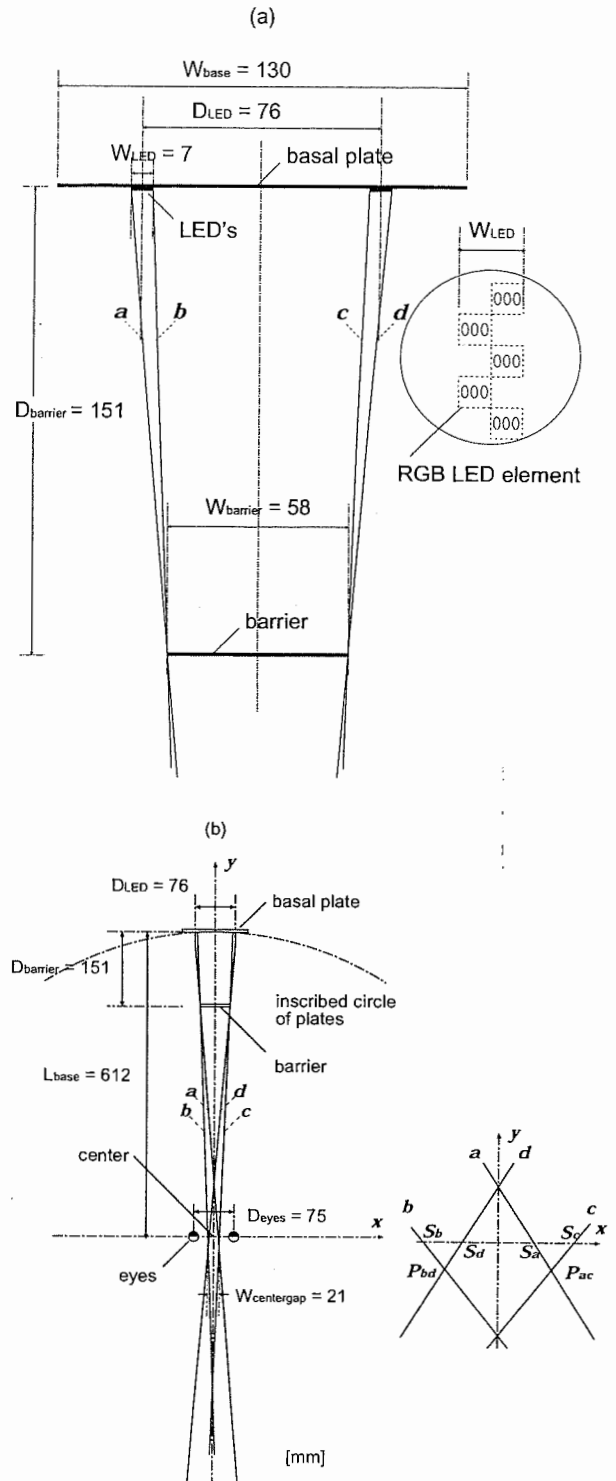

Fig. 7: Detailed parameters of parallax barriers

³Currently, as the LED element is arranged alternatively, its width is twice that of single LED element

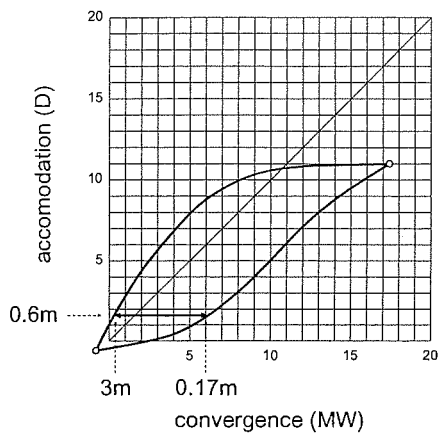

Fig. 8: The relation of accommodation and convergence, and the design of TWISTER II

3.1 The control of LED luminous intensity

Subfield method, a kind of PWM (pulse width modulation) control, was adopted in order to vary the luminous intensity of the pixels. With this method, the LED's are turned on and off according to the binary representation of the luminous level: each bit corresponds to the emission unit, which has a duration time based on the binary series (1, 2, 4, 8, ...).

3.2 The Display Gamma Characteristics

In a preliminary experimentation, we found the display gamma equals approximately to 0.9^4 , when the LED's are controlled with the subfield method (Figure 9). The luminous intensity of green LED array was measured for the duty ratio of 1, 3, 7, 15, 31, 63, 127, 255, at a distance of 0.6 meters. So we removed gamma compensation from the original image so that a linear gradation can be seen as a linear tone.

This may cause a coarse digitized tone in dim regions. So it is desirable for the image data to have more than 8 bits, especially in lower level.

4. The Experimentation and the Result

4.1 Full color presentation

With the subfield method, and inverse gamma compensation, it displayed a natural full-color still image with a continuous tone. The image data was precedently uploaded to a frame memory. In this experimentation, TWISTER II was equipped with a single display unit. Figure 10 is a photograph of the displayed image captured with a slow shutter speed of 1/4 sec.

With LED's, it can display an image that can easily be seen in a well-lit room that is bright enough for the user's face to be clearly visible. Shown in Figure 11 are the photographs of the displayed image with (right) and without (left) background lighting. These photographs also show the rich display of red in the image. The resolutions are

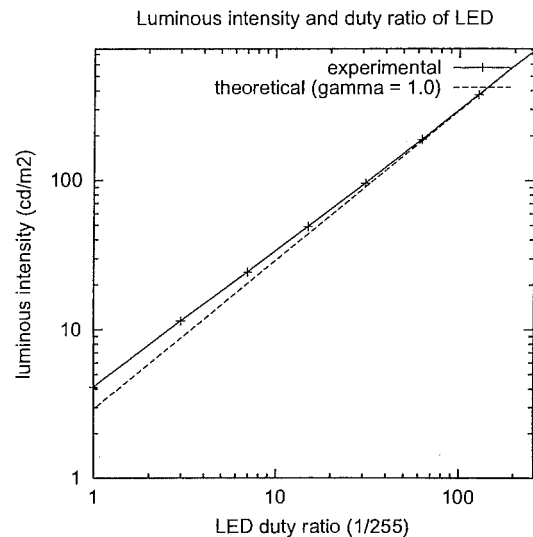

Fig. 9: The luminous intensity and the duty ratio in green LED

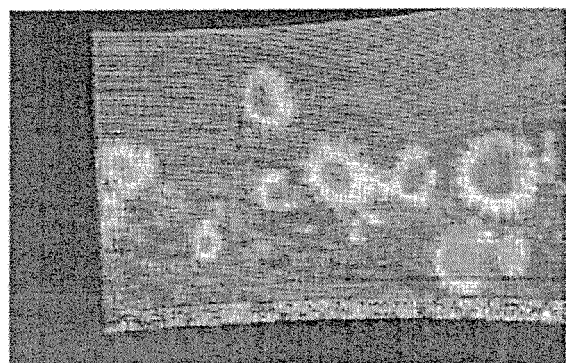

Fig. 10: Displayed natural image

⁴The exact value is $\gamma = 0.937$

720 lines/360 degrees (visual acuity of 1/20) horizontally, 128 lines (visual acuity of 1/20) vertically. As the spatial resolution is relatively low, its improvement is a further challenge.



Fig. 11: Displayed natural image with (right) and without (left) the background light

Temporal stability of the image

Since we used a single LED array in this experiment, we could perceive a stable image only near the center of the field of vision when the eyes were narrowed. We have also displayed a pseudo-motion picture (16 sequences of still images) of one frame per second using frame memory, but it was difficult to perceive it as an animation.

Ultimately making use of 30 pairs of left and right LED arrays, we anticipate a more stable picture.

4.2 Stereopsis

The observation area for stereopsis

We have also displayed a stereoscopic vision, and confirmed the depth of the vision was perceived. The observation area for stereopsis can be calculated using the center gap introduced in the Figure 7 (b). Figure 12 shows how to plot the observation area for stereopsis.

In (a), the dashed line shows the left and right limit. As the display unit turns, the limit varies like the dotted line until the left and right eyes exceed the limit (chained line). θ_{limit} is the rotation angle of this condition. θ_{limit} can be calculated using approximation that the limit lines are almost parallel to the y -axis.

$$\theta_{limit} = \cos^{-1} \left(\frac{D_{eyes}}{W_{centergap}} \right) \quad (3)$$

In the actual condition, θ_{limit} equals approximately to 66 degrees.

On the other hand, the condition that left (right) eye can't exceed the left (right) limit makes another limitation (b). When the dashed line is the left and right limit, two chained lines shows the outer limit of the middle point of left and right eyes. As the display unit rotates, the limit curve rotates correspondingly, and the x -intercepts of the curves are $\pm(D_{eyes} - W_{centergap})/2$. The half-tone dot meshing area is the common inside of the limit as θ (the rotation angle) increases from 0 to θ . Generally,

the common inside of the limit plots a parallelogram or a diamond and the size is determined by $W_{centergap}$. Concluding these discussions, in the actual condition for the 90 degrees of angle of view for instance, the observation area for stereopsis becomes a diamond whose cross size is about 60mm. This value is comparatively small, and we anticipate enlarging the size by minimizing the center gap.

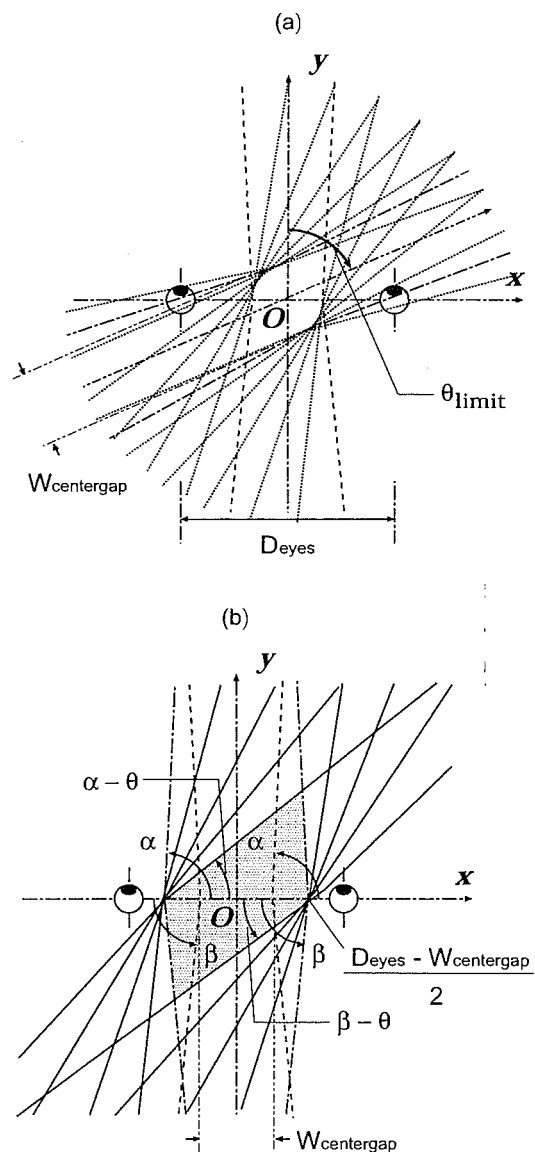

Fig. 12: The limitations of the observation position

5. Conclusion

The design, development and basic experiments and evaluations of TWISTER II, an autostereoscopic display for full-color images, was reported. We have confirmed it can display full-color still images. With LED's, it can display

Table 1: The Specifications of TWISTER II (The goal and the actual)

Specifications	Goal	Actual
Horizontal Resolution (lines / 360 degrees)	7200	720
(visual acuity)	8/20	1/20
Vertical Resolution (lines)	512	128
(visual acuity)	4/20	1/20
Frame rate (frames per second)	30	1
Horizontal Field Angle (degrees)	360	64
Vertical Field Angle (degrees)	40	40
Color Expression	Full Color	Full Color
Tonal Resolution (for each component)	256	256 *
Rotation Speed of the display unit (rpm)	180	60
Autostereopsis	possible	possible
Head tracking	possible	-

* coarse at lower level

an image that can easily be seen in a well-lit room that is bright enough for the user's face to be clearly visible. The tonal resolution was sufficient while the spatial resolution was relatively lower.

We could also confirm the performance the moving parallax barrier as a key device for an autostereopsis. The depth of the three dimensional images could be perceived. The observation area for stereopsis was comparatively small, however.

We are currently considering specification improvements (Table 1). The desired resolution is 7200 lines/360 degrees (visual acuity of 8/20) horizontally, 512 lines (visual acuity of 4/20) vertically, and 30 frames per second for temporal resolution, and these figures should further be confirmed to be sufficient for our goal. We are also to take efforts to expand the observation area for stereopsis. Capturing the observer's face and realtime image capture and display is future works, too.

Acknowledgement

This work has been supported by CREST of JST(Japan Science and Technology Corporation)

References

1. S. Tachi, T. Maeda, Y. Yanagida, M. Koyanagi and H. Yokoyama: "A Method of Mutual Tele-Existence in a Virtual Environment," Proceedings of the ICAT'96, pp. 9-18 (1996)
2. Y. Kunita, M. Inami, T. Maeda and S. Tachi: "Prototype System of Mutual Tele-Existence," ACM SIG-

GRAPH '99 Conference Abstracts and Applications, p. 267 (1999)

3. C. Cruz-Neira, D. J. Sandin and T. A. DeFanti: "Surround-Screen Projection-Based Virtual Reality: The Design and Implementation of the CAVE," Proceedings of ACM SIGGRAPH '93, pp. 135-142 (1993)
4. M. Hirose, T. Ogi, S. Ishikawa and T. Yamada: "A Development of Immersive Multiscreen Display (CABIN)," Proceedings of the Virtual Reality Society of Japan Second Annual Conference, pp. 137-140 (1997)
5. F. Okuno, H. Hoshino, J. Arai and I. Yuyama: "Real-time Pickup Method for a Three-dimensional Image based on Integral Photography," Applied Optics, Vol.36, No.7, pp. 1598-1603 (1997)
6. T. Honda, D. Nagai, R. Inagaki and M. Shimomatu: "Development of 3-D display system by Fan-like Array of Projection Optics (FAPO)," Proceedings of the 3D Image Conference 2001, pp. 165-168 (2001)
7. D. J. Sandin, T. Margolis, G. Dawe, J. Leigh and T. A. DeFanti: "The Varrier Auto-Stereographic Display," Stereoscopic Displays and Virtual Reality Systems VIII, Proceedings of the SPIE Vol. 4297, pp. 204-211 (2001)
8. Y. Kunita, M. Inami, T. Maeda, S. Tachi: "Design of Visual Display for Mutual Tele-Existence," Proceedings of the Virtual Reality Society of Japan Second Annual Conference, pp. 352-353 (1997)
9. Y. Kunita, N. Ogawa, A. Sakuma, M. Inami, T. Maeda and Susumu Tachi: "Immersive Autostereoscopic Display for Mutual Teleexistence: TWISTER I (Teleexistence Wide-angle Immersive STEReoscope model I)," Proceedings of the IEEE VR 2001, pp.31-36 (2001)
10. Y. Kunita, N. Ogawa, A. Sakuma, M. Inami, T. Maeda and S. Tachi: "Immersive Autostereoscopic Display for Mutual Teleexistence: TWISTER I (Teleexistence Wide-angle Immersive STEReoscope model I)," Proceedings of the 3D Image Conference 2000, pp. 111-114 (1999)
11. Y. Kunita, M. Inami, T. Maeda and S. Tachi: "Real-time rendering system of moving objects," Proceedings of the 1999 IEEE Workshop on Multi-View Modeling & Analysis of Visual Scenes (MVIEW'99), pp. 81-88 (1999)
12. Y. Kunita, M. Inami, T. Maeda and S. Tachi: "Real-Time Rendering System of 3D Moving Objects," Proceedings of the 3D Image Conference '99, pp. 13-18 (1999)
13. Y. Kunita, M. Inami, T. Maeda and S. Tachi: "A Real-time Projection System of Photo-Realistic Human Figures into Three-Dimensional Virtual Environments," Proceedings of the 5th Symposium on Intelligent Information Media (IIM 1999), pp. 207-212 (1999)

14. Y. Kunita, M. Inami, T. Maeda and S. Tachi: "Immersive Autostereoscopic Display for Mutual Telexistence (II): Design and Development of TWISTER II," Proceedings of the Virtual Reality Society of Japan 5th Annual Conference, pp. 369-370 (2000)