

A Method for Smooth Task Execution Under Different Master/Slave Visual Parameters

Yasuyuki YANAGIDA* and Susumu TACHI**

* RCAST, The University of Tokyo
4-6-1 Komaba, Meguro-ku, Tokyo 153 Japan
yanagida@star.rcast.u-tokyo.ac.jp
<http://www.star.rcast.u-tokyo.ac.jp/~yanagida/>

** Dept. of Mathematical Engineering and Information Physics,
Faculty of Engineering, The University of Tokyo
7-3-1 Hongo, Bunkyo-ku, Tokyo 113 Japan
tachi@star.t.u-tokyo.ac.jp
<http://www.star.rcast.u-tokyo.ac.jp/>

Abstract

In the situations when the field of view of the camera mounted on the head of the slave robot cannot be set identical to that of the head mounted display, the operator recognizes the remote environment as a strange world. Even though, the strangeness in doing tasks can be reduced by controlling the rotational motion of the head of the slave robot. Focusing on the vestibulo-ocular reflex, a method to set the scaling factor of the head rotation is shown.

Key words: tele-existence, master-slave system, head mounted display (HMD), field of view (FOV), vestibulo-ocular reflex (VOR), virtual environment

1. Introduction

Using the technology of tele-existence, the operator can execute tasks easier than by using conventional tele-operation techniques, as he/she can recognize the remote environment as a natural three dimensional space^[1]. When executing tasks by tele-existing in real and/or virtual environment, it is important for the system to ensure the operator that the environment is recognized as a natural three dimensional space and the task can be executed with ease. To implement this characteristics, the system has to be designed such that the consistency between the kinesthetic sensation and the visual sensation is kept. According to our previous experiment^[2], tele-existence operations are executed most efficiently when the kinesthetic parameters and the visual parameters of the slave robots and/or virtual human are set identical to those of the master system.

However, there exists a situation in which the parameters of the slave robots and/or virtual human cannot be set identical to that of the master system. For example, we can consider the following situations:

- When the operator supervises multiple robots of different types, he/she has to control the robots with different kinesthetic and/or visual parameters, using a single master control system. For example, in the concept of R-Cube (Real-time Remote Robotics: R³)^[3], the operator controls various type of remote robots through network, using a master system

called R-Cube console. The operator has to control multiple types of robots using a single console.

- Suppose that the operator is given the tasks in which he/she should look about wide area in the remote/virtual environment, such as exploring in the unknown environment to find something. As the most of head mounted displays (HMD) currently available have a significantly restricted field of view (FOV) compared with that of ordinary human being, the operator may feel uneasy to complete the task. In such a case, one might want to get wider field of view at a glance. The field of view for the HMD, however, cannot be changed, which implies the necessity of using larger FOV for the remote camera than that of the HMD.

In this paper, we focus on the difference between the visual parameter of the master side and that of the slave side, especially the difference between the field of view of cameras mounted on the robot head and that of the HMD used by the operator. In Section 2, we describe the mapping of video image from the remote camera to the display and point out the problem if different value of the field of view is used. In Section 3, we propose a method to reduce the influence of the strangeness, regarding vestibulo-ocular reflex^[1] (VOR). The effect of the FOV and VOR in the field of virtual reality has been investigated related with simulator sickness^[5], however, they are dedicated to examine the influence on human being when exposed to simulators or virtual reality systems. In Section 4, an experiment was made using virtual environment to show the applicability of the proposed method.

2. Mapping video image from camera to display

Major visual parameters related to tele-existence/virtual reality tasks are as follows:

- (a) distance between the two viewing points (cameras),
- (b) field of view of the camera or projection transformation used to create graphics images.

If these parameters of the camera and the HMD are set identical to each other, the operator can feel as if he/she actually exists in the remote robot or the virtual human, i.e., he/she recognizes the objects in the remote/virtual environment just as they are located with actual size. When the operator rotates his/her head and the robot or virtual human follows his/her motion with accuracy and no latency, he/she does not have to pay much attention to the existence of the system which intermediate the operator and the remote/virtual environment. This fact implies the system provides visual display consistent with the mechanism of human being's vestibulo-ocular reflex (VOR).

However, if the condition of identity for either of above parameters is violated, inconsistency between the displayed environment and the ordinary environment occurs. When the distance between two cameras are different from that of the operator's eyes, the operator feels as if he/she becomes giant or small human, depending upon whether the distance between cameras are wider or narrower than the distance of the operator's eyes. Figure 1 (a) shows the effect caused by this difference. If the operator executes tasks using hands under such a condition, the best performance is obtained by controlling the position of the end effector/hand such that its translational motion is scaled by the factor equal to the ratio of the camera distance to the eye distance^[2].

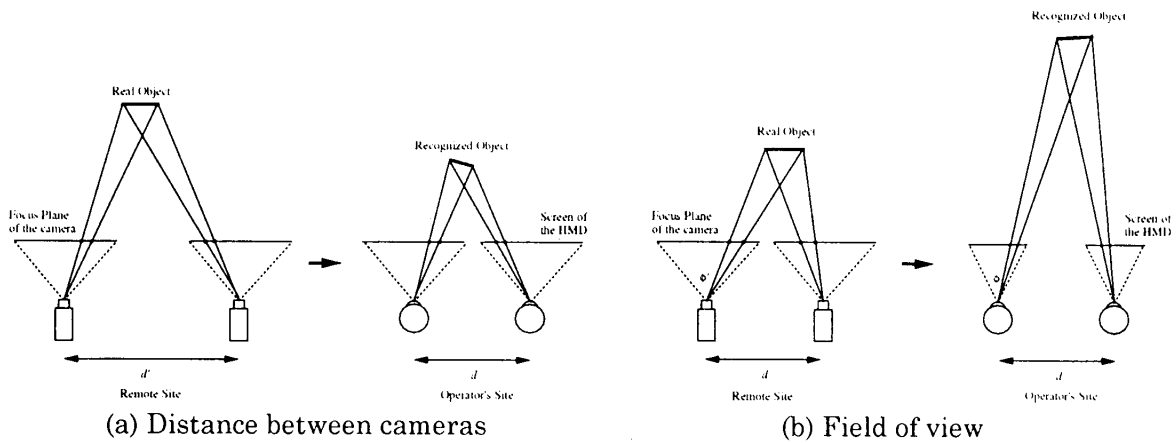

Figure 1. Effect of using different visual parameters at the remote site

The effect of the second parameter, the field of view, is more critical. If we use cameras whose field of view is different from that of the HMD and if we simply display the video image obtained from the camera to the HMD, the image of the world is expanded or shrunk, depending upon whether the camera's FOV is smaller or larger than that of the HMD. Figure 1 (b) shows the effect caused by this difference. This situation causes the operator to recognize the remote/virtual environment as a strange world. The strangeness can be categorized as follows:

1. The world is distorted, the size of the object in the world seems to be different from the actual one, and the distance from the operator to the object seems to be incorrect. This phenomenon is inherent if the image with different FOV is projected on the HMD, the influence of which is hard to be eliminated.
2. In typical tele-existence systems, the head of the slave robot is controlled to follow the operator's head motion. If the field of view of the robot camera is identical to that of the HMD and the robot is controlled with accuracy and no time delay, the operator feels that he/she actually exists in the remote world, i.e., the whole world exists stable regardless of how he/she moves the head. However, when this condition of identity is broken, the displayed image flows unexpectedly, i.e., the operator feels as if the world is stuck to his/her head or excessively moving in the opposite direction against the head motion.

In this paper, we restrict ourselves to the latter factor.

An explicit method to obtain natural three dimensional visual sensation is to convert the video image to fit the FOV of the HMD. Using this method, we have to use HMDs with a wide FOV, if we want to get video images with wide FOV at a glance. However, HMDs with extremely wide FOV using conventional display devices degrade the quality of images in the sense of available pixel resolution, which result in forcing the operator to look at blurred, unclear image. The current status, which HMDs with wide FOV and high resolution are not yet available, requires an alternative method to avoid such strangeness.

3. A method to reduce the effect of the FOV inconsistency

In order to realize smooth task execution under such a situation, we are going to explore a method to eliminate the influence of the image flow. Here we propose a method to control the head rotation of the slave robot using a certain scaling factor. This factor should be set such that the condition for vestibulo-ocular reflex (VOR) is satisfied. If this condition is satisfied, the operator is considered to feel that a point in the world is still, as far as he/she gazes at that point, though the whole image is still distorted.

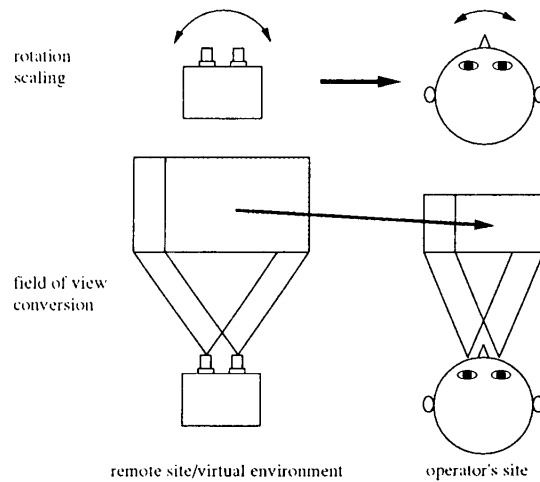

Figure 2. Concept of the proposed method

Figure 2 shows the concept of the method. The robot's head is equipped with stereo cameras whose FOV is different from that of the HMD. The video image obtained by the robot camera is directly displayed to the HMD and the rotational motion of the robot head is increased or decreased depending on whether the FOV of the camera is wider or narrower than that of the HMD.

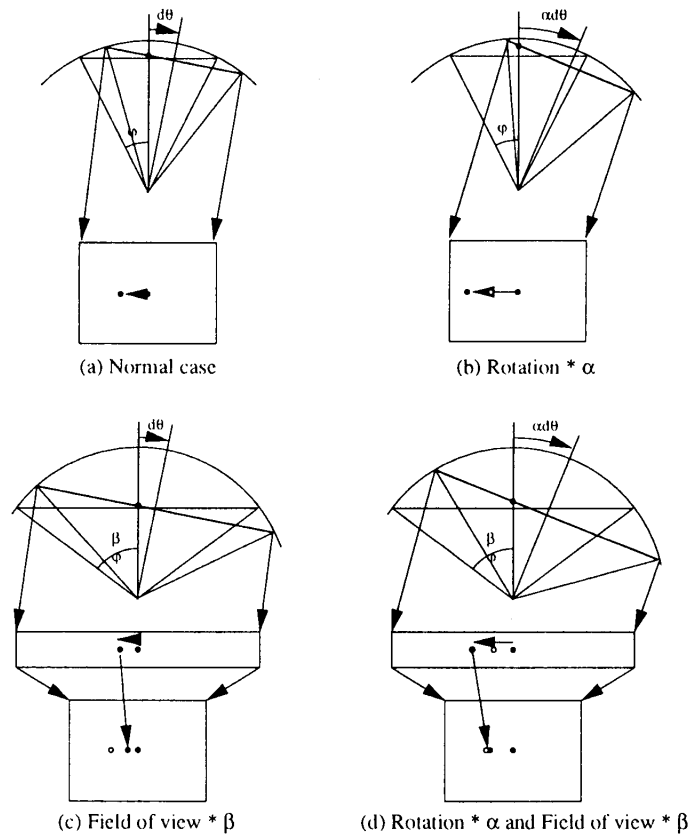

Figure 3. Scaling FOV and head rotation

Consider the HMD whose FOV is 2ϕ , as shown in Figure 3. Figure 3 (a) shows the normal case, in which the gazing point moves to the left in the displayed image as a result of the operator's head rotation to the right. If we control the robot head such that the amount of the rotation

angle is α times as large as that of the operator's motion (Figure 3 (b)), the shift of the point becomes larger ($\alpha > 1$) than that of the normal case. Next, let us consider the case in which the FOV of the camera is β times as wide as that of the HMD, as shown in Figure 3 (c). In this case, the obtained image by the camera is shrunk ($\beta > 1$) when displayed to the HMD, so that the image shift becomes less than the normal case. Finally, in Figure 3 (d), both of the head rotation and FOV are scaled. If we setup the scaling factor for the head rotation α appropriately according to the value of the FOV scaling factor β , the shift amount of the gazing point can be identical to that of the normal case. In this case, we can satisfy the condition of consistent VOR.

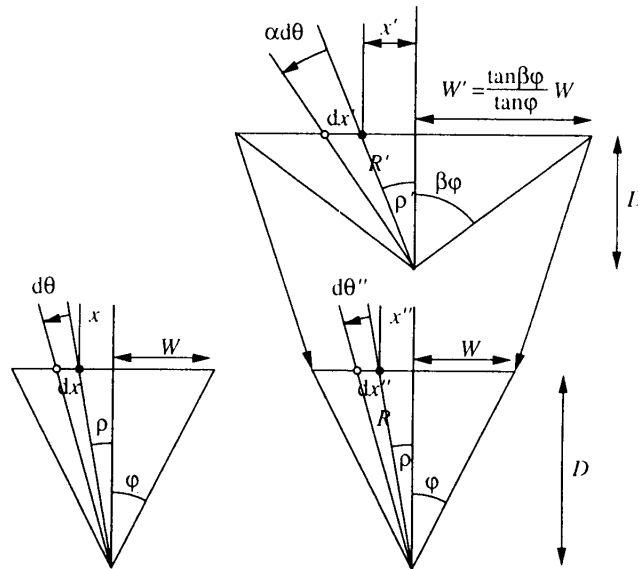

Figure 4. Calculation of the relationship between two scaling factors

The relationship between the scaling factors for the head rotation and that of the FOV which satisfy VOR condition is calculated as follows:

$$\alpha = \frac{\tan(\beta\varphi)}{\tan\varphi} \cdot \frac{1 + \xi^2 \tan^2\varphi}{1 + \xi^2 \tan^2(\beta\varphi)},$$

$$\xi = x / W,$$

where

- α : Scaling factor for the head rotation angle,
- β : Scaling factor for the field of view,
- φ : Half of the original field of view of the HMD,
- x : Distance from the center of the screen to the gazing point,
- W : Distance from the center of the screen to the edge of the screen (half of the screen width),
- ξ : ratio of "the distance from the center of the screen to the gazing point" to "the distance from the center of the screen to the edge of the screen".

The meaning for each variable is shown in Figure 4. The above equation was obtained by letting the angle $d\theta'$ on the screen which displays the shrunk image identical to the original rotation angle $d\theta$.

4. Experiment

In order to confirm the effectiveness of the proposed method, an experiment was made using a

virtual environment^[6]. By using the virtual environment, it was able to control the visual parameter setting easily, as the field of view for the generated image and the scaling factor for the head rotation were controlled by software.

The configuration of the experimental system is shown in Figure 5. The HMD whose field of view is 40 degrees in horizontal was used. The rotational motion of the subject's head was measured by rotary encoders attached to the link mechanism, the end of which was a helmet equipped with the HMD. By using this system, the subject's head motion was measured with high accuracy and no time delay. This master systems is able to measure 19 degrees of freedom (DOF) data including head translation, right arm motion, etc., though only 3 DOF data for the head rotation was used. The measured data were converted into numerical values by the PC, and sent to the graphics workstations which render the image of the virtual environment.

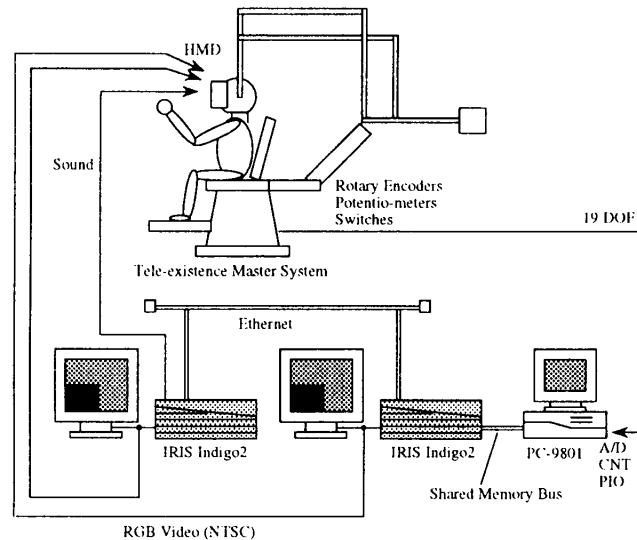

Figure 5. Configuration of the experimental system.

In the experiment, a cross cursor virtually fixed to the subject's head was displayed in front of the subject, and the subject was asked to track a target by rotating his/her head. The target was driven by a low-pass filtered random signal. The motion of the target and the subject's head were recorded to calculate their cross-correlation. The results for four cases were compared:

- (a) Normal case: the field of view of the virtual camera was set identical to that of the HMD and the rotation angle of the virtual camera was set identical to the subject's motion.
- (b) Rotation scaled: the scaling factor for the rotation angle was set to 2.3, whereas the field of view remained identical to that of the HMD. The scaling factor value of 2.3 was calculated by substituting the value of the field of view and the HMD and that of the camera ($\beta = 80/40 = 2$) at the center of the display ($\xi = 0$).
- (c) Field of view scaled: the field of view of the camera was set to 80 degrees in horizontal (twice as large as that of the HMD), whereas the rotation angle remained identical to that of the subject.
- (d) VOR satisfied: the field of view of the camera was set to 80 degrees and the scaling factor for the rotation angle was set to 2.3. In this case the condition for the vestibulo-ocular reflex was satisfied.

Figure 6 shows the sequence of the horizontal rotation (yaw angle). In each diagram, the solid line shows the rotational angle of the target, and the dashed line shows the angle of the operator's head rotation.

In Figure 6 (b), an overshoot is found in the head motion, which means the operator rotates the head too much against the target, as the camera head rotates unexpectedly large if the operator rotates his/her head as usual. In Figure 6 (c), an undershoot or large time lag is found, indicating the necessity of assistance of further visual feedback. In Figure 6 (d), the operator's motion is similar to the normal case (a).

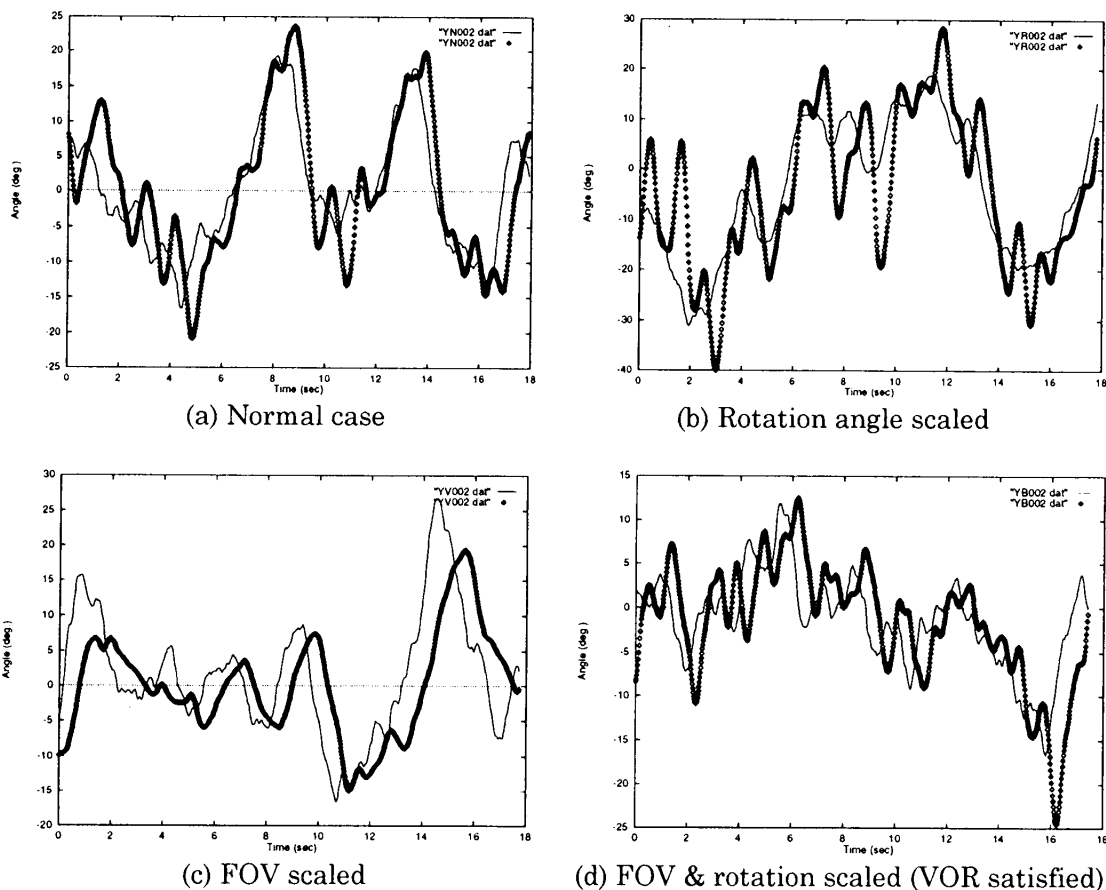

Figure 6. Head rotational motion of the operator

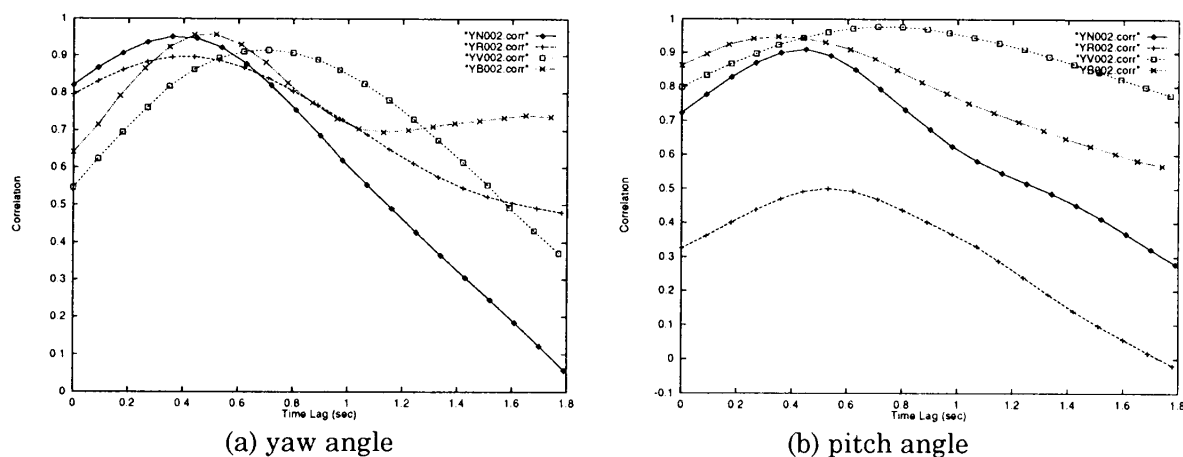

Figure 7. Cross correlation of the target and head motion

Next, cross-correlation of the target and head motion is calculated for each case. The maximal values were compared to estimate the accuracy of the tracking task, and their time delay value were compared to estimate the temporal characteristics for the subject. The result is shown in

Figure 7. In each diagram, the line with diamond marks shows the normal case, the line with “+” marks shows the “rotation scaled” case, the line with square marks shows the “FOV scaled” case, and the line with “x” marks show the “VOR satisfied” case. The maximal values and the time lags at the maximal value are shown in Table 1. Compared with the normal case, the “rotation scaled” case and the “FOV scaled” case showed the degradation on the accuracy and the time delay, respectively. On the other hand, the “VOR satisfied” case showed acceptable value for both of the accuracy and time delay.

Table 1. Maximal value and time lag of the cross-correlation
(a) normal case, (b) rotation scaled, (c) FOV scaled, (d) FOV & rotation scaled

	yaw		pitch	
	Maximal value	Time lag [sec]	Maximal value	Time lag [sec]
(a)	0.95	0.36	0.91	0.45
(b)	0.90	0.36	0.50	0.53
(c)	0.91	0.71	0.98	0.80
(d)	0.96	0.52	0.95	0.35

5. Concluding remarks

A method to enable smooth task execution by reducing the influence of inconsistency on FOV between master and slave systems was proposed, and its effectiveness was shown by a tracking experiment. Of course, the ideal system is the one that the FOV of the camera and the HMD is designed identical to each other. The method proposed here is an alternative solution under existence of inevitable restriction.

References

- [1] S. Tachi and K. Yasuda: Evaluation Experiments of Tele-existence Manipulation System, Proceedings of the 3rd International Conference on Artificial Reality and Tele-Existence (ICAT '93), pp.17-26, Tokyo, Japan (1993)
- [2] Y. Yanagida and S. Tachi: Coherency of Kinesthetic and Visual Sensation in Virtual Reality, Proceedings of the 1994 IEEE International Conference on Multisensor Fusion and Integration for Intelligent Systems (IEEE-MFI '94), Las Vegas, Nevada, USA, pp.455-462 (1994)
- [3] URL <http://www.irofa.com/rcube/>
- [4] M. Draper: Can Your Eyes Make You Sick? Investigating the Relationship between the Vestibulo-Ocular Reflex and Virtual Reality, Unpublished paper, Human Interface Technology Lab, University of Washington, Seattle, WA. (1996) (<http://www.hitl.washington.edu/projects/vestibular/dis1.html>)
- [5] Eugenia M. Kolasinski: Simulator sickness in virtual environments, U.S. Army Research Institute Technical Report 1027 (1995) (<http://www.cyberedge.com/4a7a.html>)
- [6] Y. Yanagida and S. Tachi: Virtual Environment Construction Method Using Class Library, The Transactions of the Institute of Electrical Engineers of Japan C, Vol.115-C, No.2, pp.236-244 (1995) [in Japanese]