

# Position Control System of a Two Degree of Freedom Manipulator with a Passive Joint

Hirohiko Arai and Susumu Tachi, *Member, IEEE*

**Abstract**—The authors propose a method of controlling the position of a manipulator with passive joints that have holding brakes instead of actuators. In this method, the coupling characteristics of manipulator dynamics are used, and no additional mechanisms are required. In this paper, the effectiveness of the method is verified by experiments using a prototype manipulator. The prototype is a two-degree-of-freedom (dof), horizontally articulated manipulator. The first axis is an active joint, and the second axis is a passive joint. While the brake of the passive joint is released, the passive joint is indirectly controlled by the motion of the active joint through the use of dynamic coupling. While the brake is engaged, the active joint is controlled. By combining these two control modes, total position of the manipulator is controlled. The experiments show that the precise positioning of the passive joint is feasible by use of the proposed method.

## I. INTRODUCTION

THE NUMBER of degrees of freedom (dof) that a manipulator possesses is commonly equal to the number of joint actuators. In order to reduce weight, cost, and energy consumption of a manipulator, various approaches have been proposed for controlling a manipulator that has more dof than actuators [1]. However, they require special mechanisms in addition to the basic links and joints.

On the other hand, the dynamics of a manipulator are nonlinear and highly coupled. When each joint is controlled by a local linear feedback loop, these factors result in disturbance. The elimination of such disturbances has been one of the major problems in the control of a manipulator [2]–[4]. However, the force of this disturbance is available to drive a joint, which in itself does not have an actuator. These factors are utilized in several control methods [5].

As a means of controlling a manipulator that has more joints than actuators without additional mechanisms, the authors have proposed a method of controlling passive joints that have holding brakes instead of actuators by using dynamic coupling. In a previous report [6], the principle of this method and the condition that ensures controllability of the passive joints was presented. The number of controllable degrees of freedom is equal to the number of the actuators. The controllability of the passive joints depends on nonsingularity of the coupling part of the inertia matrix. An algorithm for point-to-point (PTP) control of the manipulator was also presented. The feasibility of the method was demonstrated by computer simulation of a manipulator with two dof.

In this paper, a two dof horizontally articulated manipulator with a passive joint has been developed. The effectiveness of the proposed method was experimentally verified by this prototype manipulator. The control algorithm and the design of the control system is described.

Manuscript received June 18, 1990; revised August 3, 1990.

The authors are with the Robotics Department, Mechanical Engineering Laboratory Ministry of International Trade and Industry, Tsukuba, Japan.  
IEEE Log Number 9041487.

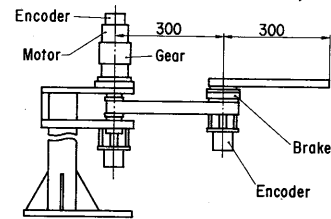

Fig. 1. Two-degree-of-freedom manipulator.

## II. PROTOTYPE MANIPULATOR

### A. Hardware Structure of the Manipulator

The view of the prototype manipulator with two dof is shown in Fig. 1. The first joint is an active joint with an actuator, and the second joint is a passive joint that has a holding brake instead of an actuator. The lengths of both link 1 and link 2 are 300 mm, and the mass distribution of link 2 is uniform. The actuator of the active joint is a 35-W dc motor with a 1/50 harmonic-drive gear. The motor torque is controlled by motor current. A PWM current amplifier is used. The maximum power of the amplifier is  $\pm 75$  V,  $\pm 4$  A, and 300 W. The holding brake of the passive joint is an electromagnetic type with a single friction disk. The static friction torque of the brake is 12 Nm. In order to achieve high-speed operation, the brake is driven by an over-excitation controller. An optical encoder is used to detect the angle of each joint. The encoder of the active joint is 200 000 P/R at the output shaft of the actuator. The encoder of the passive joint is 24 000 P/R.

### B. Mathematical Model of the Manipulator

The prototype is modeled in Fig. 2, where

- $\phi$  angle of the active joint
- $\psi$  angle of the passive joint
- $m_1(m_2)$  mass of the link 1 (link 2)
- $L$  length of the link 1
- $l_1(l_2)$  distance between the first (2nd) joint and the center of gravity of link 1 (link 2)
- $J_1(J_2)$  moment of inertia around the center of gravity of link 1 (link 2).

The equation of motion of the manipulator is written as follows:

$$M_{11}\ddot{\phi} + M_{12}\ddot{\psi} + D_{112}\dot{\phi}\dot{\psi} + D_{122}\dot{\psi}^2 + c_\phi\dot{\phi} + C_{\phi s} = \tau_\phi \quad (1)$$

$$M_{21}\ddot{\phi} + M_{22}\ddot{\psi} + D_{211}\dot{\phi}^2 = 0 \quad (2)$$

$$M_{11} = J_1 + m_1 l_1^2 + J_2 + m_2 l_2^2 + m_2 L^2 + 2m_2 L l_2 \cos \psi + J_M$$

$$M_{12} = M_{21} = J_2 + m_2 l_2^2 + m_2 L l_2 \cos \psi$$

$$M_{22} = J_2 + m_2 l_2^2 \quad D_{112} = -2m_2 L l_2 \sin \psi$$

$$D_{122} = -m_2 L l_2 \sin \psi \quad D_{211} = m_2 L l_2 \sin \psi$$

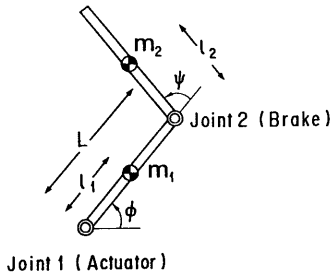

Fig. 2. Model of the manipulator.

and where  $J_M$  is the moment of inertia of the actuator,  $c_\phi$  is the viscous friction coefficient of the active joint,  $C_{\phi S}$  is the Coulomb friction torque of the active joint; and  $\tau_\phi$  is the actuator torque of the active joint, where, it is assumed that each link is a rigid body, the friction torque of the passive joint is negligible, and the actuator torque can be controlled in proportion to the input voltage of the amplifier.

### III. CONTROL SYSTEM

When the holding brake of the passive joint is engaged, the active joint can be controlled without affecting the state of the passive joint. When the holding brake is released, the passive joint can rotate freely and is controlled indirectly by the coupling torque generated by the motion of the active joint. The position of the manipulator is controlled by combining these two control modes.

Therefore, the control system of the manipulator is composed of the following three levels.

- 1) Feedback control, which causes the angle and angular velocity of the passive joint to follow desired values when the brake is released
- 2) trajectory planning and trajectory control of the passive joint while the brake is released
- 3) PTP control of the manipulator including switching of the brake and control of the active joints.

In this section, the basic principle of control of the passive joint is introduced first, and then, the composition of control at each level is discussed.

#### A. Principle of Control

The coefficients of inertia ( $M_{11}$ ,  $M_{12}$ ,  $M_{21}$ ,  $M_{22}$ ), the Coriolis/centrifugal torques ( $D_{112}\dot{\phi}\dot{\psi}$ ,  $D_{122}\dot{\psi}^2$ ,  $D_{211}\dot{\phi}^2$ ), and the friction torques ( $c_\phi\dot{\phi}$ ,  $C_{\phi S}$ ) can be determined if the measured value of the joint angle and angular velocity at each joint is substituted in  $\phi$ ,  $\dot{\phi}$ ,  $\psi$ , and  $\dot{\psi}$  of the equations of motion (1) and (2). Furthermore, when a desired value ( $=\dot{\psi}_d$ ) is assigned to the acceleration  $\ddot{\psi}$ , (2) is considered to be a linear equation with regard to  $\ddot{\phi}$ . If  $M_{21} \neq 0$ , (2) can be solved uniquely as

$$\ddot{\phi} = -\frac{M_{22}\ddot{\psi}_d + D_{211}\dot{\phi}^2}{M_{21}}. \quad (3)$$

When (3) is substituted in (1)

$$\tau_\phi = \left( M_{12} - \frac{M_{11}M_{22}}{M_{21}} \right) \ddot{\psi}_d - \frac{M_{11}D_{211}\dot{\phi}^2}{M_{21}} + D_{112}\dot{\phi}\dot{\psi} + D_{122}\dot{\psi}^2 + c_\phi\dot{\phi} + C_{\phi S}. \quad (4)$$

If the torque  $\tau_\phi$  thus derived actuates the active joint, angular

accelerations  $\ddot{\phi}$ ,  $\ddot{\psi}_d$  arises. In other words, although the passive joint is free, the angular acceleration of the passive joint can be arbitrarily determined by the torque of the active joint.

#### B. Feedback Control

In order to cause the angle and angular velocity of the passive joint to follow desired values while the brake is released,  $\tau_\phi$  of (4) is taken to be feedforward term, and a feedback term is also added. Then, the following PID control law is applied:

$$\tau'_\phi = \tau_\phi + K_{v\psi}(\dot{\psi}_d - \dot{\psi}) + K_{p\psi}(\psi_d - \psi) + K_{i\psi} \int (\psi_d - \psi) dt \quad (5)$$

where  $\psi_d$ ,  $\dot{\psi}_d$ , and  $\ddot{\psi}_d$  are desired values of the angle, angular velocity, and angular acceleration of the passive joint, respectively.  $\psi$  and  $\dot{\psi}$  are measured values of the angle and angular velocity. When the torque calculated by (5) is applied at the active joint, the following relation can be obtained from (1), (2), (4), and (5):

$$\left( M_{12} - \frac{M_{11}M_{22}}{M_{21}} \right) (\ddot{\psi}_d - \ddot{\psi}) + K_{v\psi}(\dot{\psi}_d - \dot{\psi}) + K_{p\psi}(\psi_d - \psi) + K_{i\psi} \int (\psi_d - \psi) dt = 0 \quad (6)$$

where  $\psi_d - \psi$  is guaranteed to converge to zero if  $K_{p\psi}$ ,  $K_{v\psi}$ , and  $K_{i\psi}$  are selected appropriately. In the experiments of the next section, the gains are set so that the pole of the system (6) is a triple root after a bit of trial and error.

Feedback of the angular velocity of the passive joint is included in control law (5). However, since the resolution of the encoder to measure  $\psi$  is lower than that of  $\phi$ , a relatively large quantizing error occurs when  $\dot{\psi}$  is determined from the numerical differentiation of  $\psi$ . Moreover, because of the compliant factor at the gear between the encoder and the motor, oscillation arises when the feedback gain is high. In order to increase the stiffness while retaining stability, a new control law was tested in which proportional/integral feedback of  $\psi$  is combined with velocity feedback of  $\phi$ .

If a centrifugal torque is negligible and the value of  $M_{21}$  scarcely changes, integrating both sides of (2) produces

$$(\dot{\psi} - \dot{\psi}_0) \doteq -\frac{M_{21}}{M_{22}}(\dot{\phi} - \dot{\phi}_0). \quad (7)$$

When  $\dot{\phi}_d$  is the desired angular velocity of the active joint, the new feedback law is in the form of

$$\tau'_\phi = \tau_\phi - \frac{M_{21}}{M_{22}} K_{v\psi}(\dot{\phi}_d - \dot{\phi}) + K_{p\psi}(\psi_d - \psi) + K_{i\psi} \int (\psi_d - \psi) dt. \quad (8)$$

It may produce a result approximately equivalent to the feedback of (5). Note that  $\dot{\phi}_d$  is not an arbitrary desired value; it is a value obtained by integration of  $\ddot{\phi}_d$  in (3).

The method mentioned above can be interpreted as a special case of the method in which the value of  $\dot{\psi}$  is estimated by a state observer. State equations of the system are obtained from linear approximations of (1) and (2) as

$$\dot{x} = Ax + b\tau \quad (9)$$

$$x = \begin{bmatrix} \phi \\ \psi \\ \dot{\phi} \\ \dot{\psi} \end{bmatrix} A = \begin{bmatrix} 0 & 0 & 1 & 0 \\ 0 & 0 & 0 & 1 \\ 0 & 0 & -N_{11}c_\phi & 0 \\ 0 & 0 & -N_{21}c_\phi & 0 \end{bmatrix}$$

$$b = \begin{bmatrix} 0 \\ 0 \\ N_{11} \\ N_{21} \end{bmatrix} M^{-1} = \begin{bmatrix} N_{11} & N_{12} \\ N_{21} & N_{22} \end{bmatrix}$$

Of the state variables,  $y = [\phi, \psi, \dot{\phi}]^T$  are assumed to be detected as outputs, and a minimal order observer, which estimates  $\dot{\psi}$ , is designed. ( $\dot{\phi}$  is obtained from the numerical differentiation of  $\phi$ .)

$$\begin{aligned} \dot{z} &= \hat{a}z + \hat{b}y + \hat{j}\tau \\ \hat{\psi} &= z + hy \end{aligned} \quad (10)$$

where  $h = [h_1, h_2, h_3]$  are assigned for design parameters. Each coefficient is determined by Gopinath's method as follows:

$$\begin{aligned} \hat{a} &= -h_2 \\ \hat{b} &= [-h_1h_2, -h_2^2, -h_1 \\ &\quad - (N_{21} - N_{11}h_3)c_\phi - h_2h_3] \\ \hat{j} &= N_{21} - N_{11}h_3. \end{aligned} \quad (11)$$

Since the pole of the observer is  $-h_2$ , it is stable if  $h_2 > 0$ . When  $h_1 = 0$  and  $h_3 = N_{21}/N_{11}$  ( $= -M_{21}/M_{22}$ ) respectively

$$\begin{aligned} \dot{z} &= -h_2z - h_2^2\psi + \frac{M_{21}}{M_{22}}h_2\dot{\phi} \\ \hat{\psi} &= z + h_2\psi - \frac{M_{21}}{M_{22}}\dot{\phi}. \end{aligned} \quad (12)$$

Therefore,  $\hat{\psi}$  can be estimated from  $\psi$  and  $\dot{\phi}$  only.

The observer (12) can be represented as a transfer function in the following form:

$$\hat{\Psi} = \frac{h_2}{s + h_2} s\Psi + \frac{s}{s + h_2} \left( -\frac{M_{21}}{M_{22}} \dot{\phi} \right). \quad (13)$$

Consequently,  $\hat{\psi}$  is obtained as sum of the differentiated value of  $\psi$  filtered by the first-order LPF with a cut-off frequency of  $h_2/2\pi$  and  $-(M_{21}/M_{22})\dot{\phi}$  filtered by the first-order HPF of the same cut-off frequency. If  $h_2 = 0$ ,  $\hat{\psi} = -(M_{21}/M_{22})\dot{\phi}$ . Therefore, the same value as with (8) is fed back. However, when  $h_2 = 0$ , the deviation of  $\hat{\psi}$  from  $\dot{\psi}$  does not converge to zero, and error arising from the centrifugal torque and temporal change of  $M_{21}$  is accumulated. In the control law (8),  $\phi_d$  is obtained by integrating (3), in which these factors are taken in account so that errors from these factors may be compensated.

### C. Trajectory Control of the Passive Joint

Positioning of the passive joint is achieved along a desired trajectory while the brake of the passive joint is released. In this part, design of desired trajectory and trajectory control for the passive joint are described. The initial value of the joint angle is taken to be  $\psi_0$ , and the desired value is taken to be  $\psi_{\text{end}}$ . The desired trajectory  $\psi_d(T_1 \leq t \leq T_2)$  should satisfy the following

three conditions:

- $\psi_d(T_1) = \psi_0, \psi_d(T_2) = \psi_{\text{end}}$
- $\dot{\psi}_d(T_1) = \dot{\psi}_d(T_2) = 0$
- $\psi_d(t)$  ( $T_1 \leq t \leq T_2$ ) is a finite value.

Of these, a) is the condition for executing positioning along the trajectory, b) is a boundary condition because at the moment of the brake switching, the passive joints must be at rest, and c) is the condition that the desired trajectory can be realized physically.

Furthermore, the lag in brake operation time (10–20 ms for ON → OFF, 20–50 ms for OFF → ON) is considered, and the following condition is added:

- $\dot{\psi}_d(t) = 0$  ( $T_1 \leq t \leq T'_1, T'_2 \leq t \leq T_2$ ).

The brake is released at  $T_1$  and the brake is engaged at  $T'_2$ .  $T'_1 - T_1 = 20$  ms and  $T_2 - T'_2 = 60$  ms.

The following time function is used as the trajectory that satisfies all the above conditions.

$$\begin{aligned} \psi_d(t) &= (T_1 \leq t \leq T'_1): \psi_0 \\ &= (T'_1 \leq t \leq T'_2): \psi_0 + (\psi_{\text{end}} - \psi_0) \\ &\quad \cdot \left\{ \frac{t - T'_1}{T'_2 - T'_1} - \frac{1}{2\pi} \sin \frac{2\pi(t - T'_1)}{T'_2 - T'_1} \right\} \\ &= (T'_2 \leq t \leq T_2): \psi_{\text{end}}. \end{aligned} \quad (14)$$

In addition, a maximum value  $\tau_{\phi \text{max}}$  is defined for the active joint torque.  $T_2 - T_1$  is determined so that the inertial part of the active joint torque does not exceed this value. From (4)

$$\ddot{\psi}_d \text{max} = \left( \frac{M_{21}}{M_{12}M_{21} - M_{11}M_{22}} \right) \tau_{\phi \text{max}}. \quad (15)$$

Then

$$T'_2 - T'_1 = |2\pi(\psi_{\text{end}} - \psi_0)/\ddot{\psi}_d \text{max}|^{1/2}. \quad (16)$$

An example of a designed trajectory is shown in Fig. 3.

In order to cause the passive joint to follow the desired trajectory, feedforward calculation of (4) and feedback calculation of (8) are executed based on the desired values ( $\psi_d, \dot{\psi}_d, \ddot{\psi}_d$ ) and the measured values ( $\phi, \dot{\phi}, \psi, \dot{\psi}$ ), and  $\tau_\phi$  is determined. If the values of  $\phi_d(t)$  and of  $\tau_\phi(t)$  ( $T_1 \leq t \leq T_2$ ) are calculated in advance by the following procedure, real-time control requires only calculation of (8), and the sampling time can be reduced.

- 1) The desired trajectory of the passive joint  $\psi_d(t)$  ( $T_1 \leq t \leq T_2$ ) is prescribed, and then  $\dot{\psi}_d(t)$  and  $\ddot{\psi}_d(t)$  are determined.
- 2) The initial state of the active joint  $\phi(T_1), \dot{\phi}(T_1)$  is assigned.
- 3) Equations (3) and (4) are calculated to determine  $\ddot{\phi}_d$  and  $\tau_\phi(t)$ .
- 4) The values of  $\phi_d$  and  $\dot{\phi}_d$  after the sampling interval  $\Delta T$  are determined by numerical integration of  $\ddot{\phi}_d$  and  $\dot{\phi}_d$ .
- 5) Steps 3) and 4) are repeated, and  $\phi_d(t)$  and  $\dot{\phi}_d(t)$  are determined within the period of  $T_1 \leq t \leq T_2$ .

### D. PTP Control

In order to perform positioning between two arbitrary points, two control modes (brake ON and brake OFF) are combined, and a motion pattern is compiled. Since the passive joint is controlled with the brake released and the active joint is controlled

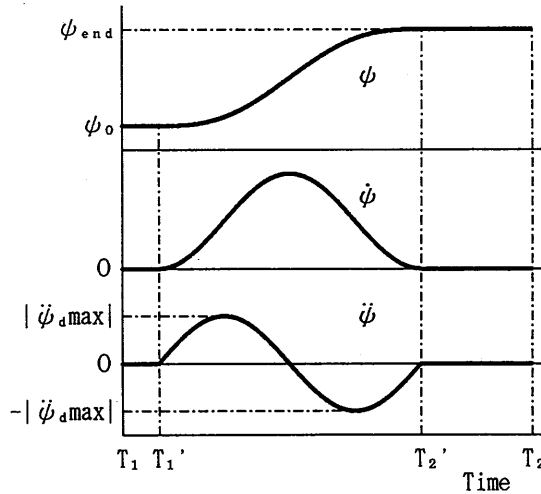

Fig. 3. Desired trajectory of the passive joint.

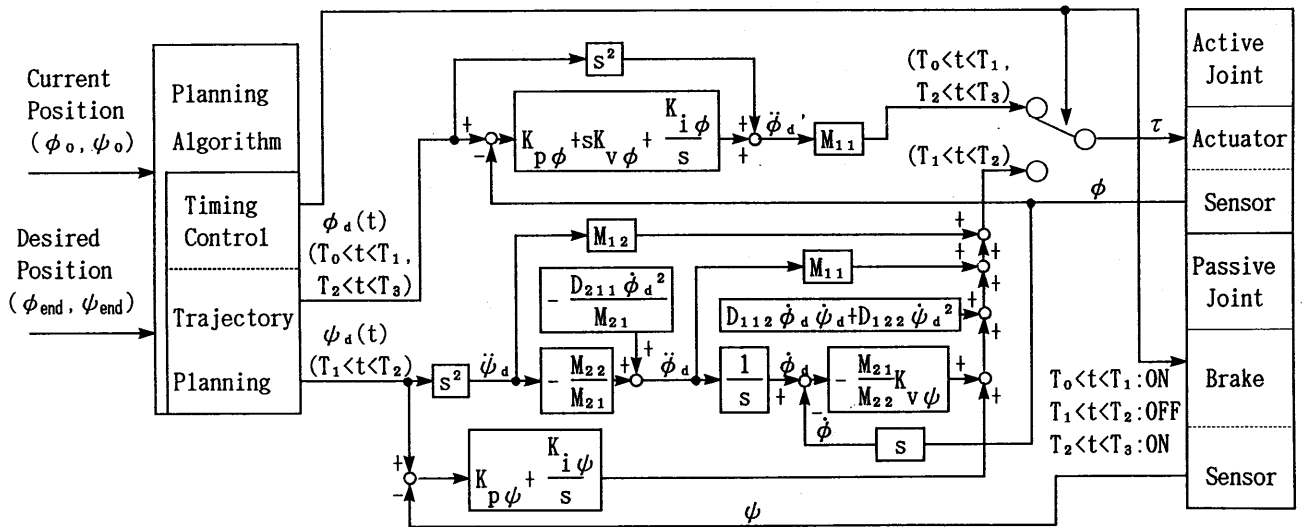

Fig. 4. Control system of the manipulator.

with the brake engaged, the control mode should be changed at least once before both joints of the manipulator are set at a desired position. Here, mode switching is performed twice, and the period of positioning is divided into the following three periods:

- i)  $T_0 \leq t \leq T_1$ , brake ON (fixed)
- ii)  $T_1 \leq t \leq T_2$ , brake OFF (released)
- iii)  $T_2 \leq t \leq T_3$ , brake ON.

In period i), initial acceleration of the active joint is performed; in period ii), positioning of the passive joint is performed; and in iii), positioning of the active joint is performed.

The initial angles of the active and the passive joints are  $(\phi_0, \psi_0)$ , and the desired angles are  $(\phi_{end}, \psi_{end})$ . Positioning of the passive joint from  $\psi_0$  to  $\psi_{end}$  in period ii) is discussed in Section III-C. In period i), control is performed in which the desired state is  $\phi = \phi_d(T_1)$ ,  $\dot{\phi} = \dot{\phi}_d(T_1)$  from the state  $\phi = \phi_0$  and  $\dot{\phi}_0 = 0$ . In period iii), control is performed in which the desired state is  $\phi = \phi_{end}$ ,  $\dot{\phi} = 0$  from the state  $\phi = \phi_d(T_2)$ ,  $\dot{\phi} = \dot{\phi}_d(T_2)$ . For period i) and iii), the maximum value of  $|\dot{\phi}|$  is determined based on the maximum torque of the active joint the same as with period ii), and the trajectory with a sinusoidal acceleration/deceleration pattern is designed. Since the initial state of the active joint  $\phi_d(T_1)$ ,  $\dot{\phi}_d(T_1)$  in period ii) can be

selected arbitrarily, it was selected by trial and error so that the time  $T_3 - T_0$  for positioning would be minimum. Feedback control of active joints in periods i) and iii) is the same as control of common manipulator joints.

The control system comprised of the three levels mentioned above is illustrated in Fig. 4.

#### IV. EXPERIMENTAL RESULTS

The values of parameters in (1) and (2) of the prototype manipulator are shown in Table I.  $M_{12}$ ,  $M_{21}$ ,  $M_{22}$ ,  $D_{112}$ ,  $D_{122}$ ,  $D_{211}$  were determined by calculation from the following conditions:  $m_2 = 1.1$  (kg),  $L = 0.3$  (m),  $l_2 = 0.15$  (m), and the mass distribution of link 2 is uniform. In addition,  $C_{\phi_s}$  was determined from the torque measurement,  $c_\phi$  from the step response, and  $M_{11}$  from the angular amplitude with respect to the sinusoidal input torque. The relation between actuator torque and amplifier input voltage was also verified experimentally.

The control system described in Section III was implemented on a personal computer (16-MHz 80386 CPU + 80387 coprocessor). The control program was written in C language. The sampling interval was 1 ms. The configuration of the control system is shown in Fig. 5.

Fig. 6 shows the results of step response by control law (5) or (8). The step change of the desired angle of the passive joint

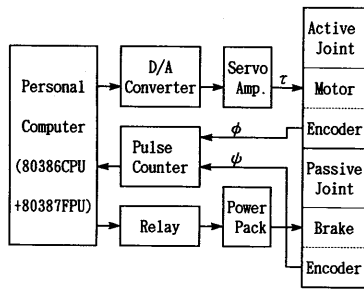
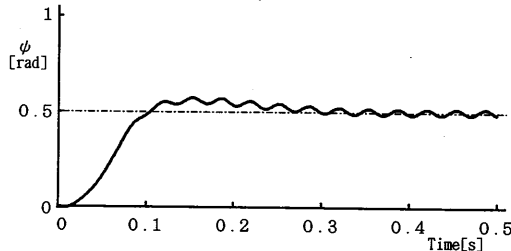
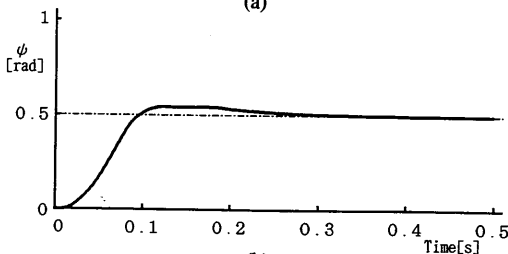

Fig. 5. Configuration of the control system.



(a)



(b)

Fig. 6. Step response of the passive joint: (a) Experimental result by feedback (5); (b) experimental result by feedback (8).

TABLE I  
PARAMETERS OF THE MANIPULATOR

$M_{11}$	$0.61 + 0.090 \sin \psi$	$[\text{kgm}^2]$
$M_{12}$	$0.030 + 0.045 \cos \psi$	$[\text{kgm}^2]$
$M_{21}$	$0.030 + 0.045 \cos \psi$	$[\text{kgm}^2]$
$M_{22}$	0.030	$[\text{kgm}^2]$
$D_{112}$	$-0.090 \sin \psi$	$[\text{kgm}^2]$
$D_{122}$	$-0.045 \sin \psi$	$[\text{kgm}^2]$
$D_{211}$	$0.045 \sin \psi$	$[\text{kgm}^2]$
$c_{\phi}$	2.2	$[\text{kgm}^2/\text{s}]$
$C_{\phi s}$	4.3	$[\text{Nm}]$

(0 → 0.5 rad) is given from the state where the manipulator is at rest. The gain has been set so that the pole of the closed-loop system is  $-34.2$  (triple root). Oscillation takes place in Fig. 6(a) by (5). In spite of the same gain, Fig. 6(b) by (8) remains stable. With control law (8), a stable response was obtained even when the position gain increased more than ten times over the gain at which oscillation began with control law (5).

Next, from the state where the manipulator is at rest, the desired trajectory is assigned to the passive joint, and tracking control was executed using the algorithm described in Section III-C. The desired trajectory of (14) was given as  $T_2 - T_1 = 0.5$  s,  $\psi_0 = 0$ ,  $\psi_{\text{end}} = 1$  (rad). Fig. 7 shows the result. Fig. 7(a) is the response by control law (8). The desired trajectory (Fig. 7(b)) was almost completely followed by the actual trajectory. The closed-loop pole was  $-41.5$  (triple root) here.

The stick diagram of the manipulator in Fig. 8 represents an

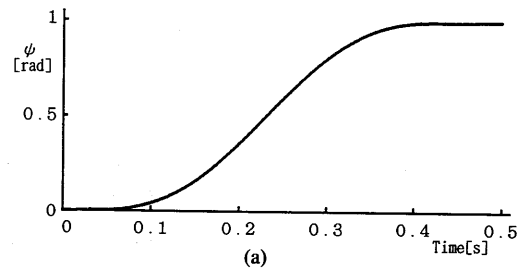

(a)

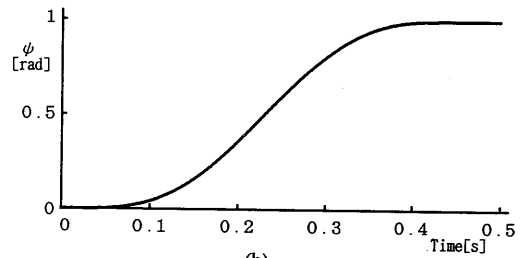

(b)

Fig. 7. Trajectory tracking of the passive joint: (a) Experimental result; (b) desired trajectory.

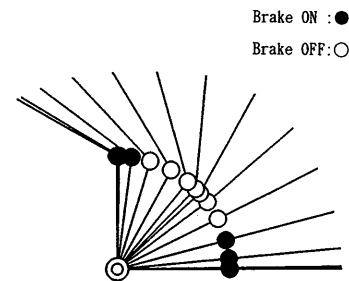

Fig. 8. PTP control of the manipulator.

experimental result of PTP control by the algorithm of Section III-D. The positioning time was 1.05 s.

Furthermore, in order to investigate the absolute accuracy of positioning,  $\phi_{\text{end}}$ ,  $\psi_{\text{end}}$  was changed every  $\pi/12$ -rad step in the range of  $\phi_0 = 0$ ,  $\psi_0 = 0$ ,  $\phi_{\text{end}} = 0 - \pi/2$ ,  $\psi_{\text{end}} = \pi/12 - \pi/2$ , and positioning was performed for each point. The positioning error of  $\psi$  (the passive joint) was less than  $1.3 \times 10^{-3}$  rad.

In order to investigate the repetitive precision, positioning was performed 100 times from  $\phi_0 = 0$ ,  $\psi_0 = 0$  to  $\phi_{\text{end}} = \pi/2$ ,  $\psi_{\text{end}} = \pi/3$ . The average value of the positioning error of  $\psi$  was  $4.5 \times 10^{-4}$  rad. The standard deviation calculated as the criteria of precision was  $1.7 \times 10^{-4}$  rad. Since the resolution of the encoder was  $2.6 \times 10^{-4}$  rad, a repetitive precision close to the optimum could be obtained.

## V. CONCLUSIONS

In this paper, a horizontally articulated manipulator with two degrees of freedom was developed. The manipulator has a passive joint comprised of a holding brake and an encoder at the second axis. Fundamental experiments on position control of the manipulator using dynamic coupling were performed. It was confirmed that positioning of the passive joint with high repetitive precision was possible by the proposed control method.

This method depends essentially on a dynamic model of the manipulator. In the experiments of this paper, each parameter of the manipulator was calculated or determined experimentally in advance. However, this method may become more effective if it

is used together with a real-time parameter identification or adaptive control method [7].

#### REFERENCES

- [1] S. Hirose and Y. Umetani, "The development of soft gripper for the versatile robot hand," in *Proc. 7th ISIR*, 1977, pp. 353-360.
- [2] J. Y. S. Luh *et al.*, "On line computational scheme for mechanical manipulators," *ASME J. Dyn. Syst. Meas. Contr.*, vol. 102, no. 2, pp. 69-76, 1980.
- [3] E. Freund, "Fast nonlinear control with arbitrary pole-placement for industrial robots and manipulators," *Int. J. Robotics Res.*, vol. 1, no. 1, pp. 65-78, 1982.
- [4] M. Vukobratović and D. Stokić, "One engineering concept of dynamic control of manipulators," *ASME J. Dyn. Syst. Meas. Contr.*, vol. 103, no. 2, pp. 108-118, 1981.
- [5] M. Vukobratović and D. Juričić, "Contribution to the synthesis of biped gait," *IEEE Trans. Biomed. Eng.*, vol. BME-16, no. 1, pp. 1-6, 1969.
- [6] H. Arai and S. Tachi, "Position control of a manipulator with passive joints using dynamic coupling," in *Proc. 20th ISIR*, 1989, pp. 617-624.
- [7] J. J. Craig *et al.*, "Adaptive control of mechanical manipulators," in *Proc. IEEE Int. Conf. Robotics Automat.*, 1986, pp. 190-195.